



More information in the QR code or  
at <http://support.sungrowpower.com/>

---

# Quick Installation Guide

DTSU666

Three-phase Smart Energy Meter

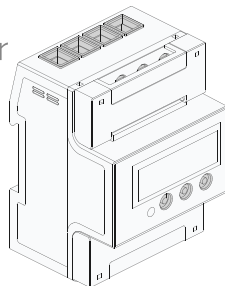

## Applicability

This manual is applicable to Sungrow Three-phase Smart Energy Meter.

- DTSU666

Keep the manual in a convenient place for future reference. The latest manual can be acquired at [support.sungrowpower.com](http://support.sungrowpower.com).

## Target Group

Only qualified personnel with the following skills are allowed to perform the work described in this document:

- Training in the installation and commissioning of electrical systems;
- Capable of coping with the dangerous and emergency situations during the installation and commissioning;
- Familiar with the country/regional standards and specifications;
- Knowledge of and compliance with this manual and other related documents.

## 1 Intended Use

- The Smart Energy Meter is designed for indoor use only. It is a measuring device detecting the electrical values at the grid-connected point. It cannot be used for billing purposes. The data collected by the Smart Energy Meter on the PV power generation may differ from the data of the main Smart Energy Meter.
- Any use other than those described in this document does not qualify as appropriate usage and is prohibited. Do not make any modifications to the product.
- Damage or destruction may be caused to the Smart Energy Meter due to inappropriate usage. The Smart Energy Meter must not be operated beyond the values specified in the technical data.
- The following figure shows an application example of the Smart Energy Meter in the PV system. The inverter figure is for your reference only.

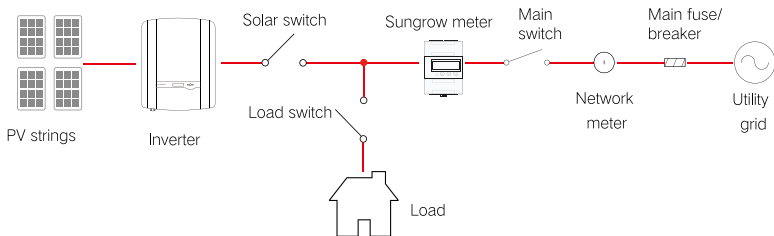

### DANGER

Lethal voltages and danger to life due to electric shock!

- Only use the Smart Energy Meter in a dry environment and keep it away from liquids.
- Install the Smart Energy Meter in the switch cabinet only and ensure that the connection areas for the line and the neutral conductors are behind an insulating cover or have contact protection.
- Install an external disconnect switch between the Smart Energy Meter and the grid-connection point. The external disconnecter must be close to the Smart Energy Meter and easily accessible.
- Disconnect the Smart Energy Meter from voltage sources before cleaning. The Smart Energy Meter must be cleaned with a dry cloth only.

## WARNING

Fire hazard !

- If a fuse is missing or incorrect, a fire may be caused when a fault occurs. This can result in death or serious injury.
- Protect the line conductors of the Smart Energy Meter with a fuse or a main/selective circuit breaker, max. 80 A.

## 2 Technical Data

| Parameters             | Specifications             |
|------------------------|----------------------------|
| Nominal voltage        | 230/400Vac                 |
| Input voltage range    | 57.7/100Vac ... 265/460Vac |
| Input current          | 3 × 5(80)A                 |
| Grid frequency         | 50Hz/60Hz                  |
| Operating temperature  | -30 °C ... +60 °C          |
| Relative humidity      | < 75%                      |
| Dimensions (W x H x D) | 72 x 65 x 100 (mm)         |

## 3 Delivery Contents

Related components in the scope of delivery:

- Smart Energy Meter
- RS485 cable
- Quick installation guide



DTSU666

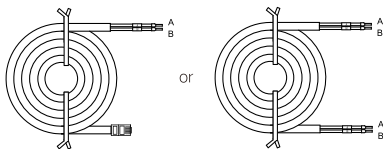

RS485 cable



Quick guide

Contact SUNGROW or the distributor in case of any damaged or missing components.

Three-phase Smart Energy Meter and its terminals

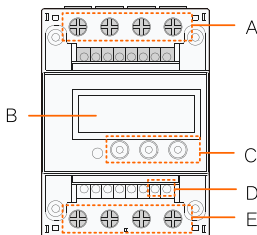

| Designation |             | Description                                                                                                                      |
|-------------|-------------|----------------------------------------------------------------------------------------------------------------------------------|
| A           | 3, 6, 9, 10 | Output terminals to the load side                                                                                                |
| B           | LCD display | Displays active energy and reactive energy, etc                                                                                  |
| C           | Key         | SET: confirm the selection or settings<br>ESC: return to a previous menu or cancel the settings<br>→: increase the setting value |
| D           | 24, 25      | Communication terminals                                                                                                          |
| E           | 1, 4, 7, 10 | Input terminals from the grid side                                                                                               |

## 4 Installation

Mount the Smart Energy Meter to a 35 mm DIN rail. Hook it into the top edge of the rail and press down until it snaps into place.

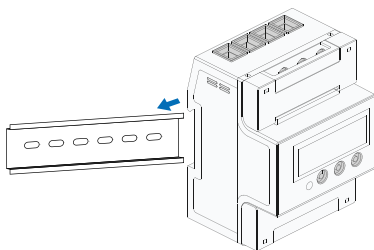

## 5 Cable Connection

- The line conductor L1 supplies power to the Smart Energy Meter. At least the line conductor L1 and neutral conductor must be connected to the Smart Energy Meter.
- Just connect the line conductor L1 (L2 and L3, if available) and the neutral conductor, then three-phase Smart Energy Meter can be used as a single-phase Smart Energy Meter.

Step 1 Turn off solar switch, load switch, main switch and other power switches, and secure them against reconnection.

Step 2 Take out the RS485 cable from inverter's packaging or Smart Energy Meter's packaging .

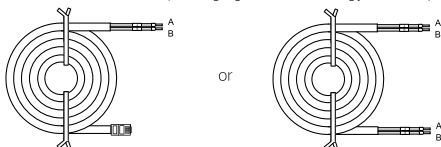

Step 3 Connect the plugs A and B to terminals 24 and 25 on the Smart Energy Meter.

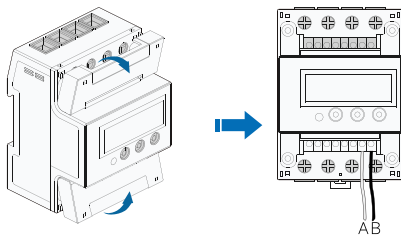

Step 4 Strip the insulation from the power wires by 10 mm. Then connect wires to the terminals on the Smart Energy Meter, as shown below. (Cross-section: 10 mm<sup>2</sup> to 25 mm<sup>2</sup>)

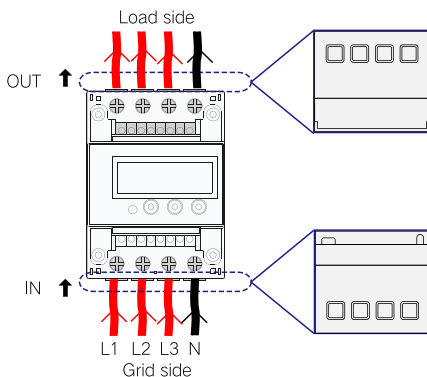

#### NOTICE

- The three-phase voltage sequence is consistent with the three-phase voltage sequence of the inverter. The terminals 1, 4, and 7 are corresponding to L1, L2, and L3 of the inverter respectively. Ensure correct cable connection.
- Connect only one of the input terminal 10 or the output terminal 10 to the N wire; or connect both of them to the N wire in series according to onsite conditions.

Step 5 For inverter cable connection, refer to the user manual of the corresponding inverter.

Step 6 Cover the Smart Energy Meter with the insulating cover or contact protection of the sub-distribution. Switch on the power supply to the sub-distribution.